



www.fb-machinery.com

Model 380-E4 Spider



K e g i o m
l i f t i n g



gru . crane . kran . grue . grúa . guindaste

Dimensioni Generali - General Dimensions - Dimensions Générales
Gesamtabmessungen - Dimensiones Generales

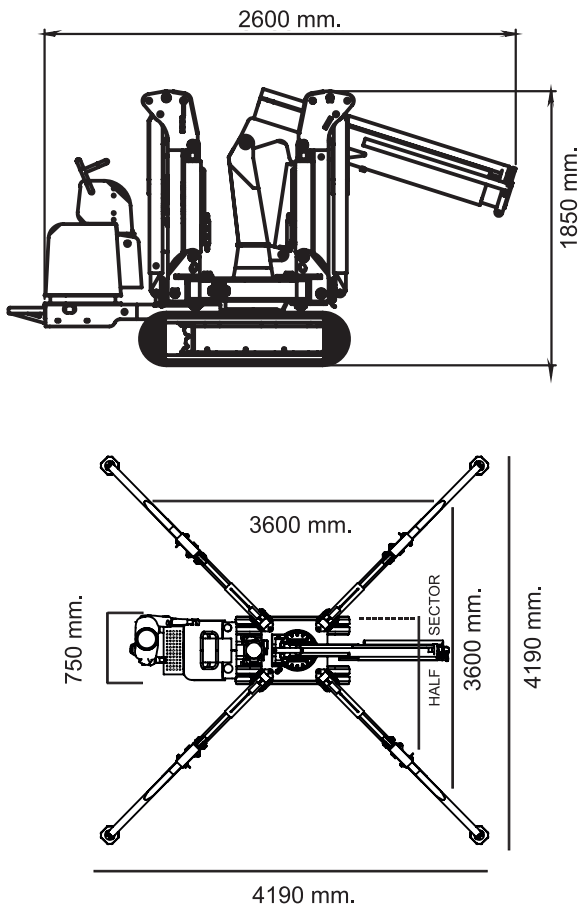

Può salire e scendere dal veicolo di trasporto con gli stabilizzatori.
Self-loading/unloading on the truck with outriggers.
Kann steigen und erhalten vom Transportfahrzeug mit den Stabilisatoren des Kran.
Peut monter et descendre du véhicule de transport grâce à ses stabilisateurs.
Puede subir y bajar del vehículo de transporte con los estabilizadores.



Tabella portata (stabilizzatori tutti estesi)
Lifting Capacity Chart (outriggers fully extended)
Tableau de Charge (stabilisateurs étendus max.)
Hublasttabelle (Abstützung ganz ausgefahren)
Tablero de Carga (estabilizadores a la máxima extensión)











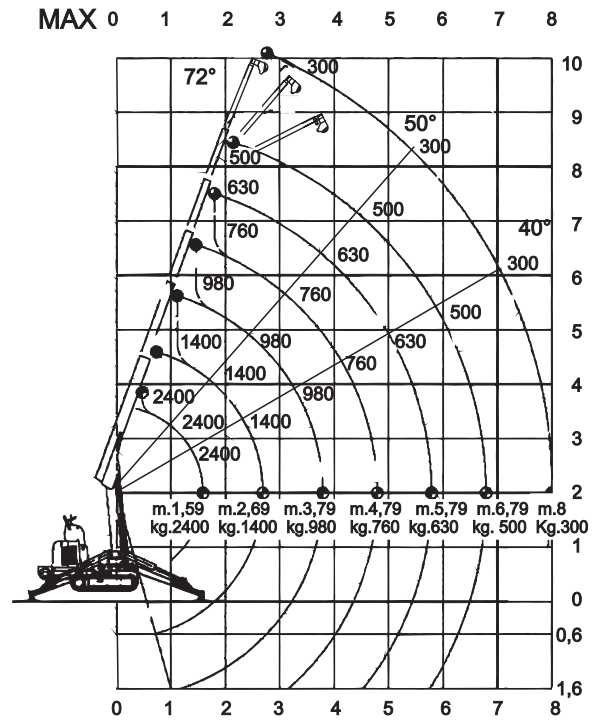
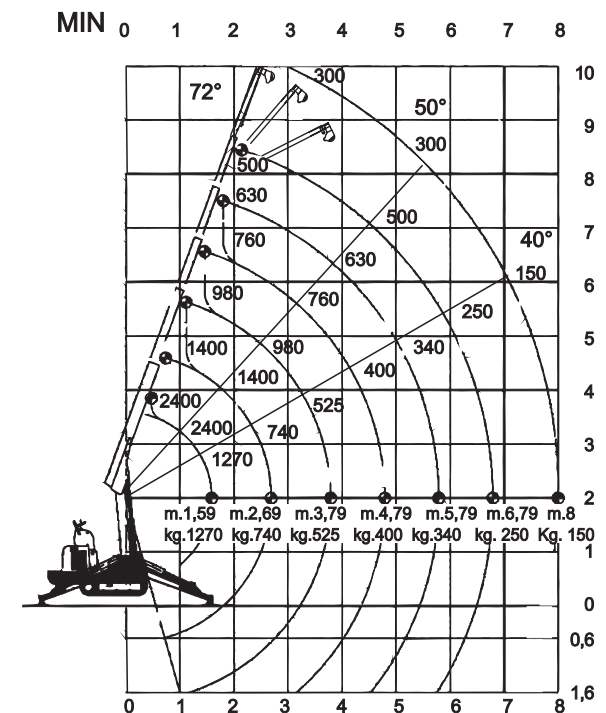



Tabella portata (stabilizzatori min. estesi)
Lifting Capacity Chart (outriggers min. extended)
Tableau de Charge (stabilisateurs étendus min.)
Hublasttabelle (Abstützung min. ausgefahren)
Tablero de Carga (estabilizadores a la mínima extensión)



DATI TECNICI TECHNICALS SHEETS TECHNISCHE DATEN CARACTERISTIQUES TECHNIQUES DATOS TECNICOS

					
Motore benzina avviamento elettr.	Motor petrol electric starting	Benzinmotor Elektrostarter	Moteur à essence démarrage élect.	Motor gasolina arranque elfctr.	Honda GX390 13HP a 3600 rpm
Capacità serbatoio	Tank capacity	Trankkapazität	Capacité réservoir	Capacidad tanque	6 l.
Trazione idrostatica a 2 velocità	Drive system hydrostatics to 2 speeds	Hydrostatischer Antrieb mit 2 Geschwindigkeiten	Transmission hydrostatique à deux vitesses	Tracciòn hidrostàtica a 2 velocidades	Km/h 2,6 4,0
Angolo di rampa	Ramp angle	Steigungswinkel	Rampe admissible	Rincòn de tramo	20° (36.4%)
Cingoli in gomma	Tracks in rubber	Raupenketten aus Gummi	Chenilles en caoutchouc	Orugas de goma	1222 x 180 x 20 mm.
Portata max	Max lifting	Max. Tragfähigkeit	Capacité maximum	Carga máxima	2400 Kg.
Sbraccio massimo	Max working radius	Max.Ausladung	Longueur de flèche max	Alcance lateral máx.	8 m.
Altezza massima	Max.working height	Tragfähigkeit bei max.Ausladung	Hauteur de levage max.	Altura max. de trabajo	10 m.
Fune	Winch rope	Seil	Câble	Cable	30/42 m. ø 8 mm.
Rotazione	Rotation	Umdrehung	Rotation	Rotaciòn	360°
Stabilizzatori	Outriggers	Abstützung	Stabilisateurs	Estabilizadores	Hydraulic multi position
Pressione al suolo	Max track loading	Bodendruck	Pression au sol	Presiòn de apoyo	0,34 Kg/cm ²
Comandi elettrico proporzionali	Electricals proportionals control	Elektrische proportionale Steuerung	Commandes électriques proportionnelles	Mandos elèctricos proporcionales	
Limitatore di momento	Automatic limiting device	Automatische Grenzlasterregelung	Limiteur de charge	Limitador de momento	Elektronico - Electronic Elektronisch - Électronique Electrónico
Pressione max	Max pressure	Max Betriebsdruck	Pression max	Max Presiòn	190 bar
Dimensioni Gru	Dimensions crane	Abmessungen Kran	Dimensions de la grue	Dimensiones grúa	2600 x 750 x 1850 mm.
Peso	Weight	Gewicht	Poids	Peso	1380 Kg.

OPTIONALS

	Verricello Winch Treuil Seilwinde Cabrestante		Elettropompa 115-220-380 V Electric pump 115-220-380 V Pompe électrique 115-220-380 V Elektrische pumpe 115-220-380 V Bomba eléctrica 115-220-380 V		Radiocomando Radio remote control Radiocommande Funkfernsteuerung Radiocomando		Cestello Basket Nacelle Personenkorb Cesta
	Prolunghe meccaniche Manuals extensions Rallonges manuelles Manuelle verlängerung Alargadores mecánicos		Allargamento idraulico cingoli mm. 750/1050 Widening hydraulic tracks mm. 750/1050 Élargissement hydraulique des chenilles mm. 750/1050 Hydraulisch ausfahrbare raupenketten mm. 750/1050 Ensanche hidráulicos orugas mm. 750/1050		Sollevatore a ventosa portata max +0 400 - 1200 Kg Vacuum lifter max lifting +0 400 - 1200 Kg élevateur à vide carga maxima +0 400 - 1200 Kg levantador de vacío capacite max +0 400 - 1200 Kg Vakuümheber max Tragfähigkeit +0 400 - 1200 Kg		



Dealer

FB Machinery
www.fb-machinery.com
info@fb-machinery.com
+36 20 584 5015

Kegiom Lifting S.r.l. - Via Duchessa di Galliera, 12
15076 Ovada (AL) - Italy
Tel./Fax (+39) 0143 822031 - 46541
e-mail: info@kegiom.com - web: www.kegiom.com
C.F. e P. Iva 01956070062 - C.C.I.A.A. Alessandria n. 213887

Kegiom si riserva il diritto di apportare qualsiasi modifica senza preavviso nè responsabilità.
Kegiom reserves the right to make changes without prior notice or responsibility.

