

sedus

Chairs, bar stools, bistro tables

meet chair & table



Leading through communication.

Man's ability to communicate has been a success factor throughout evolution. And for the modern economy, which is becoming increasingly dependent on people's intellectual and creative productivity, communication is vital.

Today's office environments therefore need to offer a variety of opportunities for people to talk to each other. About work and informally. Sedus *meet chair & table* offers a well thought-out, comprehensive and highly flexible range to this end – for the break area, bistro or meeting room.









For all requirements.

With its robust, durable quality and its ergonomic design, the Sedus *meet chair & table* programme proves its strengths in continuous use and in high-traffic areas. The one-piece seat shell in plastic or wood is easy to clean and – with or without covers – offers a high level of comfort. *meet chair & table* stand out with their high quality materials and a product design for any office environment.



product
design award



reddot design award

meet chair swivel chair and the folding standing table *meet table* have been awarded the iF and red dot design awards.

Multitasking talent.

Light in design and stackable to save space, the *meet chair* can be used in many ways. In the conference room or for meetings in-between the open workspace, for workshops or relaxed breaks in the bistro. Linked in rows they can be used as comfortable seating for training, lectures and occasional company events.



Row linkage.
Sophisticated clip system,
retrofittable without tools.

Stacking and transportation trolley.
A practical accessory
for easy transport and
space-saving storage.





For outstanding ideas.

Those who think standing up from time to time come up with measurably more ideas than colleagues sitting down. The upright posture can also have a positive effect on meeting duration and efficiency. Elegant standing tables and bar stools are the foundation. In combination with the “*over easy*” connecting element, any location can be turned into a popular meeting place for spontaneous dialogue.





Flexible—the meet chair programme.

Comfortable. meet chair visitor and swivel chairs are available in natural-looking wood or plastic shell. For the wood version, seat and backrest upholstery are available to choose from on request. The frames are made of chrome-plated steel. The four-leg version is stackable up to 10 units, and the skid version up to 14 units. Both variants can be optionally connected in rows.

Four-leg versions



Skid versions



Swivel chairs

On the move. The swivel chair is available on request with easy to use height adjustment. The plastic star base is available in black and anthracite.



Bar stools

Upright. The bar stool is used in break areas as well as in communication zones. Three chrome-plated frame variants and many material and colour options are available to choose from.



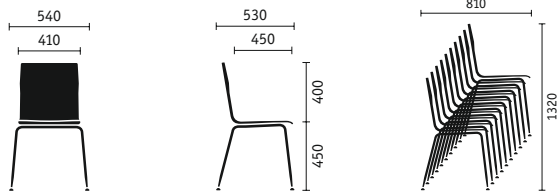

Plastics. For the one-piece, flexible plastic seat shell produced with the monosandwich technology, there are five colours to choose from.

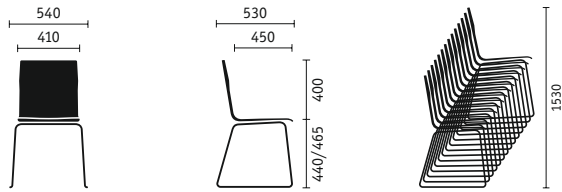
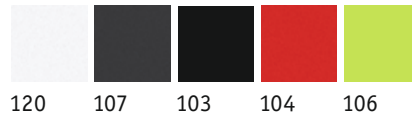

Laminates. The wooden seat shells are available with two high quality laminate coatings.

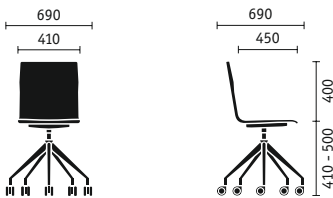

Stains. 18 colour-stained finishes can be specified, to create individual design accents.

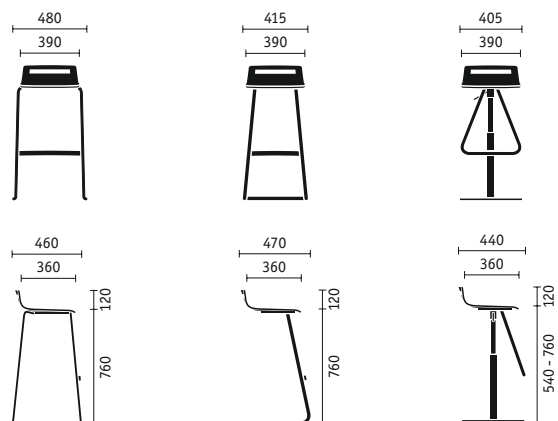

Veneers. Real wood veneers for a particularly elegant look with a high feel-good factor.



Felt. Seat covers in four colours matching the design for all chair versions without upholstery.

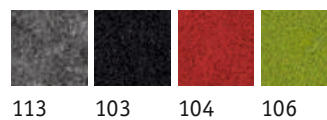

The meet table programme – a key factor for collaboration.

Bistro tables



Standing tables



Standing table, foldable, stackable



over easy connecting panels





Melamine. 19 mm chipboard with melamine resin coating and PP laser edge.



K80 K81 K82 K83 K84 K14 K74 K58 K70 K77 K78 K79 N10 N11

Veneers. 16 real wood veneers for a particularly elegant look.



C11 C17 C19 C20 D14 D15 D16 D11 E41 E10 E45 B26 H11 H12 U10 Q10

Compact top. 12 mm table top made of compact fibreboard, black chamfered edges. Tables in pure white, over easy also available in four other colours.

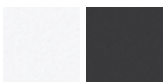

T14 T74

Felt. Table covers (diameter 385 mm) as accessories round off the programme nicely.



113 103 104 106



Company:



Sedus meet chair:



www.tuv.com
ID 0000042152



Sustainability down to the last detail.

Sustainability and quality “Made in Germany” have been key company principles at Sedus for more than 50 years. Principles that *meet chair* also reflects. They are realized by a consistently recycling-oriented product design, ecologically tested materials, resource-saving and energy-conscious production, as well as ongoing quality tests.

The *meet chair* chairs, bar stools and bistro tables are manufactured exclusively in Germany, which guarantees the highest environmental standards. Another plus in production: the ultramodern, particularly environmentally friendly electroplating facility, where all metal-containing production residues are fully recycled.



Sedus operates globally in accordance with the principles of the UN Global Compact on human rights, labour standards, environmental protection and fighting corruption.

sedus